

THE POWERFUL ASSISTANTS

SCREW COMPACTORS



H&G SCREW COMPACTORS

THE PRINCIPLE

Compacting large-volume quantities to a minimum of their original volume so efficiently that they can be disposed in a fast, labour-saving and economical way.

Thanks to their compact design and efficient mode of operation by means of an electromechanical direct drive, our systems guarantee a high process stability, are low-maintenance and achieve filling weights in the container which are almost twice as high compared to hydraulic presses.

Special feeding devices, developed by H&G, are geared to the respective waste and recyclable fractions and ensure an optimum feeding as well as a continuous high throughput.



YOUR BENEFIT WITH H&G SCREW COMPACTORS

- High filling weights, up to 8 tons of cardboard and up to 9 tons of wood, in a 32 m³ container (depending on the machine type)
- Reduction of transport costs and CO₂ emissions
- High throughput - 100 to 150 m³/h
- Optimization of process costs and internal processes
- Compact and robust design, Made in Germany

1. screw spiral
2. main drive motor
3. bearing of the screw spiral
4. pinion

5. control panel
6. central lubrication unit
7. feeding device (whirler)
8. machine ratchet
9. locking catch
10. container

STANDARD-SIZE

screw compactor without feeding device

material: mixed waste, foil polystyrene, PET-bottles (pre-treated)



screw compactor equipped with feeding device: whirler

material: paper, small cardboard boxes (maximum size up to 600x600 mm)



screw compactor equipped with feeding device for bigger and flattened cardboard with 1 shaft, manual feeding

material: small cardboard boxes, cardboards



screw compactor equipped with feeding device for bigger and flattened cardboard with 2 shafts, manual feeding

material: bigger and flattened cardboards



screw compactor equipped with feeding device: cardboard pre-crusher, automatic feeding

material: heavy duty cardboard packaging, flattened cardboards, octabins



LARGE-SIZE

screw compactor equipped with feeding device: wood breaker

material: one way wooden pallets, euro-pallets, small wooden boxes, fruit boxes, furniture wood



FILLING WEIGHTS

MATERIAL	DEGREE OF COMPACTION
paper and cardboard	250 kg/m ³
heavy duty cardboard packaging	250 kg/m ³
mixed waste	300 kg/m ³
foil	200 kg/m ³
wooden material	250 kg/m ³
PET bottles, compactor without deformer	150 kg/m ³
PET bottles, compactor with deformer	200 kg/m ³

These indications depend, among other facts, strongly on the consistency of the material: in a 32 m³ container.

SMART CONTROL TECHNOLOGY

Following the trend towards Industry 4.0 in waste management logistics, for our screw compactors we offer innovative smart control units including remote diagnostics and adjustments of different parameters. By doing so, process optimization and efficiency enhancement are guaranteed. Generated 80% full and 100% full messages are automatically sent per e-mail in order to ensure and ease your waste disposal logistics.



X-LARGE SIZE

screw compactor without feeding device

material: mixed waste, foil, plastics
composite materials

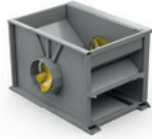

screw compactor equipped with feeding device: cardboard pre-crusher, automatic feeding

material: heavy duty cardboard packaging,
flattened cardboards, octabins



screw compactor equipped with feeding device: wood breaker

material: one way wooden pallets,
euro-pallets, large wooden boxes,
furniture wood



XX-LARGE SIZE

double screw compactor single chamber, without feeding device

material: mixed waste, foil, plastics,
composite materials



double screw compactor single chamber, equipped with feeding device: wood breaker

material: large wooden boxes,
furniture wood



double screw compactor double chamber, with or without feeding device

material: optional for mixed waste, foil,
paper, cardboards,
PET-bottles (pre-treated)



TIPPING-DEVICES

Tipping-devices are used in production plants and business enterprises where general waste and recyclables are collected centrally before being compacted. Tipping-devices, mobile or stationary, can be used with DIN-standard containers, and with the appropriate modifications, with special containers as well.

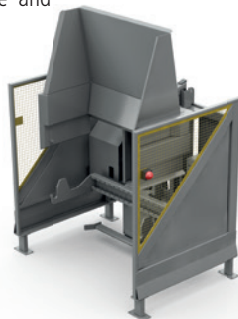

MOBILE SCREW COMPACTOR STANDARD-SIZE

All stationary screw compactors (standard size) are also available as mobile screw compactors with a container size of 23 m³/ 26 m³/ 29 m³.



DEWATERING SCREW COMPACTORS

screw compactor equipped with deformer

material: de-watering and compaction/destruction of PET/- and plastic bottles



screw compactor equipped with hydraulic pressing-channel

material: de-watering of fruits and vegetables; food packaging



screw compactor equipped with hydraulic pressing-channel

material: de-watering of residual materials; rejects

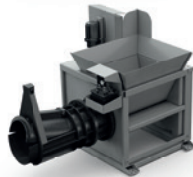

SAMPLE APPLICATIONS

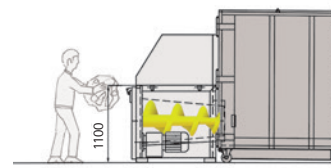

feeding from ground-level

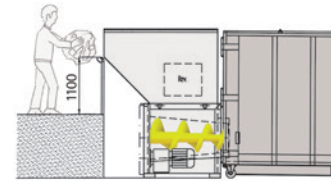

feeding from a ramp

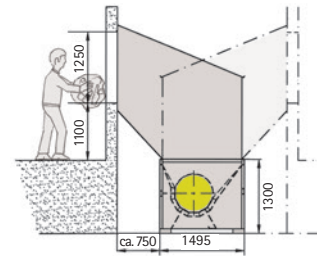

feeding via wall-connected filling chute

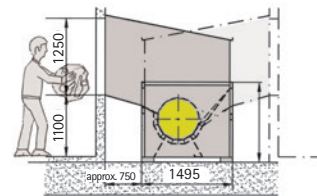

special machine housing, cut laterally

MOBILE SCREW COMPACTOR SMALL-SIZE

We offer our screw compactor small-size as a mobile and stationary solution. It can be used for high amounts of waste when less space for placing the compactor is available. Different container sizes adjust flexibly to the respective installation situation.

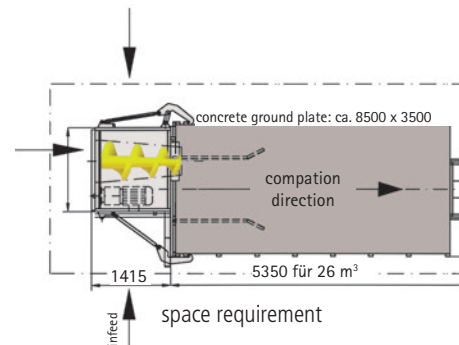







more information
HG-SYSTEMS.COM





H&G Entsorgungssysteme GmbH
Lützelner Straße 46 • D-57299 Burbach
Phone: +49 (0) 2736 / 50 96 - 0
Fax: +49 (0) 2736 / 50 96 - 140
info@hg-systems.com
hg-systems.com